

Part No.	Load Voltage	Load Current	Control Voltage	Switch Type
S24D25	12-280 Vrms	25A	4-30 Vdc	Zero Cross
S24D25M	12-280 Vrms	25A	4-30 Vdc	Zero Cross
S24R40	12-280 Vrms	40A	3-30 Vdc	Random
S24D40	12-280 Vrms	40A	4-30 Vdc	Zero Cross
S24A40	12-280 Vrms	40A	90-240 Vac/Vdc	Zero Cross
S48D25	24-520 Vrms	25A	5-30 Vdc	Zero Cross
S48R50	24-520 Vrms	50A	4-30 Vdc	Random
S48D50	24-520 Vrms	50A	5-30 Vdc	Zero Cross
S48A50	24-520 Vrms	50A	90-240 Vac/Vdc	Zero Cross
S48A50-22	24-520 Vrms	50A	17-80 Vac/Vdc	Zero Cross
S48R75	24-520 Vrms	75A	90-240 Vac/Vdc	Zero Cross
S48R125-22	24-520 Vrms	125A	17-80 Vac/Vdc	Zero Cross
S48R125	24-520 Vrms	125A	4-30 Vdc	Random
S48A125	24-520 Vrms	125A	90-240 Vac/Vdc	Zero Cross
S60D125	24-660 Vrms	125A	7-30 Vdc	Zero Cross

MECHANICAL SPECIFICATION

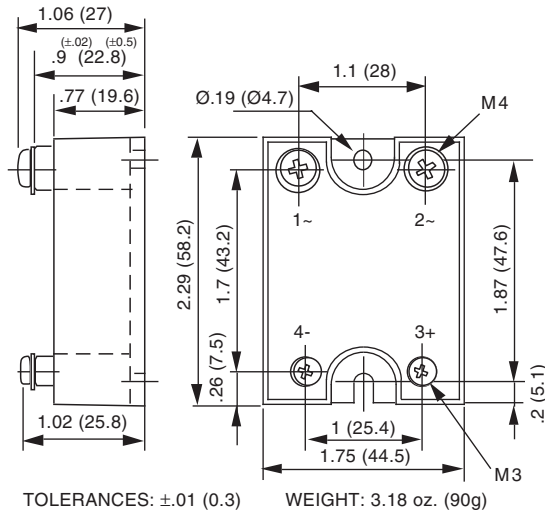

Figure 1 — S relays, 12-95 A;
dimensions in inches (mm)
125A model uses larger M5 output screw terminals

TYPICAL APPLICATION

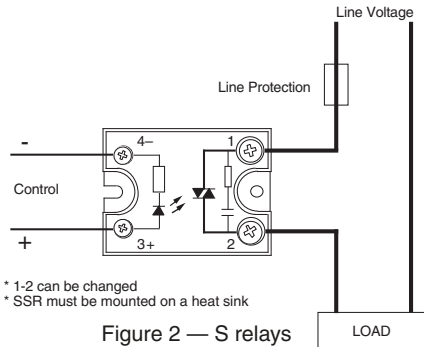

Figure 2 — S relays



Part Number Example: **S48A25-22**

NOTES

- 1) Line Voltage (nominal): 24 = 240 Vac; 48 = 480 Vac; 60 = 600 Vac
- 2) Switch Type: R = Random turn-on; D = Zero-cross turn-on; A = AC control, Zero-cross turn-on
- 3) Feature: -22 = Low Vac control. Available on A type models

FEATURES/BENEFITS

- Industry standard package
- Internal snubber (except S60 models)
- Designed for all types of loads
- AC or DC control available
- Excellent thermal performance
- Tight zero-cross window for low EMI
- High immunity to surges

DESCRIPTION

The Series S single-phase relays are designed for all types of loads. The design incorporates an SCR or triac output. The relays utilize optical isolation to protect the control from load transients. All contain an internal snubber for output protection. High-current models are excellent for motor and phase angle control.

APPLICATIONS

- Heating control
- Motor control
- Uninterruptible power supplies
- Light dimmers
- Industrial and process control
- On/Off controls of AC equipment

APPROVALS

S24 and S48 models are UL recognized.
UL File Number: E128555.

For RoHS Compliant Contact Factory

INPUT (CONTROL) SPECIFICATION

		Min	Max	Units
Control Range				
S24	R	3	30	Vdc
	D	4	30	Vdc
S48	R	4	30	Vdc
	D	5	30	Vdc
S60	D	5	30	Vdc
SxxA	A	90	240	Vac/Vdc
Sxxxx-22	A	17	80	Vac/Vdc

Input Current Range

S	R/D	3	30	mA
S	A	3	8	mA
Sxxxx-22	A	5.6	26	mA

Must Turn-Off Voltage

S	R/D	1	Vdc
S24	A	15	Vac
S48	A	1	Vac
Sxxxx-22		3	Vac

Input Resistance (Typical)

S	R/D	1000	Ohms
S	A	30,000	Ohms
Sxxxx-22		3000	Ohms

Reverse Voltage Protection

S	R/D	30	V
S	A		NA

CONTROL CHARACTERISTICS

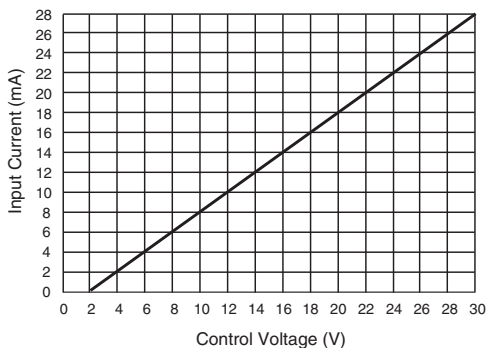

Figure 3a — S48R, S48D and S60D relays

CONTROL CHARACTERISTICS

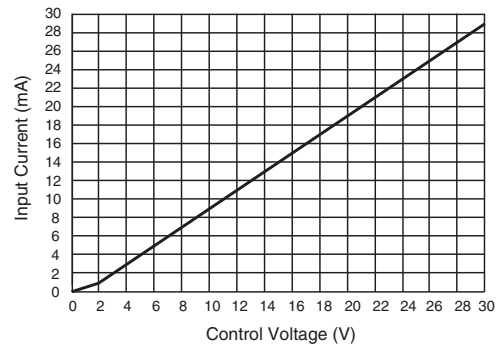

Figure 3b — S24D/R relays

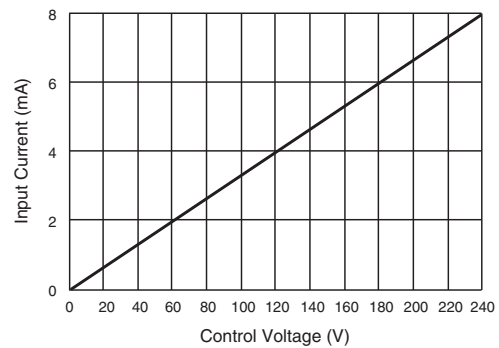

Figure 3c — S24A and S48A relays

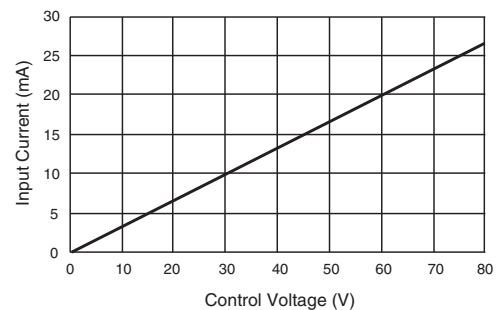

Figure 3d — Sxxxx-22 relays

OUTPUT (LOAD) SPECIFICATION				OUTPUT (LOAD) SPECIFICATION (continued)			
	Min	Max	Units		Min	Max	Units
Operating Range				On-State Voltage Drop			
S24	12	280	Vrms	12A output current		1.3	V
S48	24	520	Vrms	25A output current		1.2	V
S60	24	660	Vrms	40A output current		1.4	V
				50A output current		1.4	V
				125A output current		1.3	V
				S60D125		1.1	V
Peak Voltage				Zero-Cross Window (Typical)			
S24		600	Vpeak	S	R	NA	V
S48		1200	Vpeak	S	D/A	±12	Vac
S60		1600	Vpeak				
Load Current Range (Resistive)				Off-State Leakage Current (60Hz)			
12A output current	.005	12	Arms	S24		3	mA
25A output current	.005	25	Arms	S48	D/A	3	mA
40A output current	.005	40	Arms	S48	R	2.5	mA
50A output current	.005	50	Arms	S60	A	1	mA
125A output current	.005	125	Arms				
Inductive Load Current				Turn-On Time (60Hz)			
12A output current		2.5	Arms	S	R	0.1	ms
25A output current		5	Arms	S	D	8.3	ms
40A output current		9	Arms	S	A	24.9	ms
50A output current		12	Arms				
125A output current		30	Arms	Turn-Off Time (60Hz)			
Capacitive Load Current				S	R/D	8.3	ms
S60D125		48	Arms	S	A	24.9	ms
Maximum Surge Current Rating (Non-Repetitive)				Off-State dv/dt			
12A output current		120	A			500	V/μs
S24, 25A output current		240	A	Maximum di/dt (Non-repetitive)			
S48, 25A output current		230	A			50	A/μs
40A output current		350	A				
50A output current		550	A				
125A output current		2000	A				

OUTPUT (LOAD) SPECIFICATION (continued)

	Min	Max	Units
Operating Frequency	0.1	440	Hz
I²T for match fusing (<8.3ms)			
12A output current		72	A²S
S24R25		312	A²S
S24D/S24A 25A output current		288	A²S
S48 25A output current		265	A²S
40A output current		612	A²S
50A output current		1500	A²S
125A output current		20000	A²S

ENVIRONMENTAL SPECIFICATION

	Min	Max	Units
Operating Temperature	-40	100	°C
S48D50	-55	100	°C

Storage Temperature	-40	+100	°C
---------------------	-----	------	----

Input-Output Isolation	4000	Vrms
------------------------	------	------

Output-Case Isolation

12A output current	2500	Vrms
25A output current	2500	Vrms
40A output current,R	2500	Vrms
40A output current,D	3300	Vrms
40A output current,A	3300	Vrms
50A output current	3300	Vrms
125A output current	3300	Vrms

SURGE CURRENT

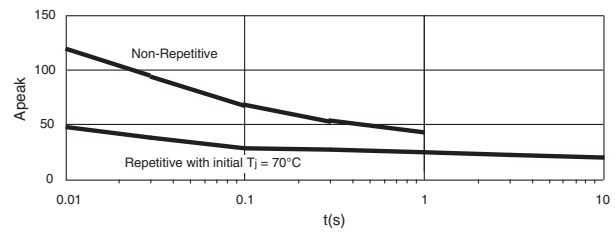

Figure 4a — 12A output current

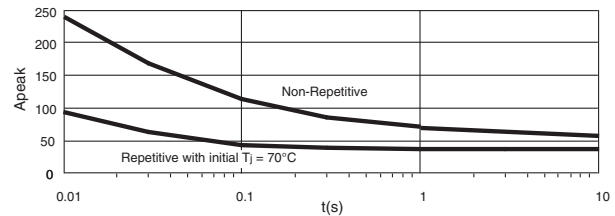

Figure 4b — 25A output current

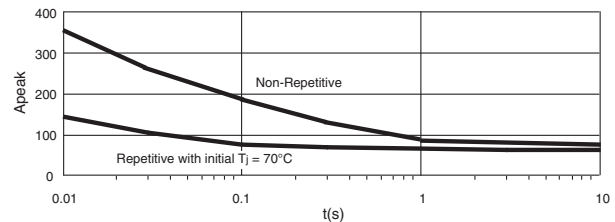

Figure 4c — 40A output current

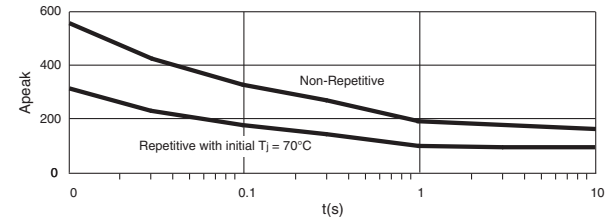

Figure 4d — 50A output current

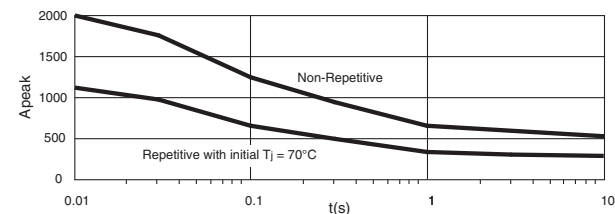

Figure 4g — 125A output current

THERMAL CHARACTERISTICS

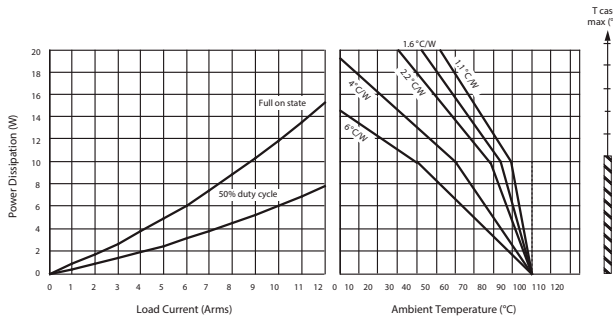

Figure 5a — 12A output current

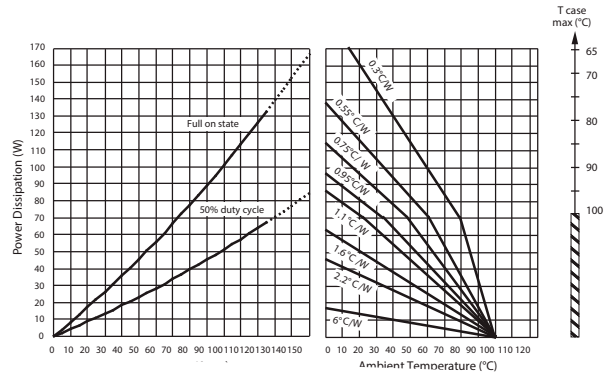

Figure 5e — 125A output current

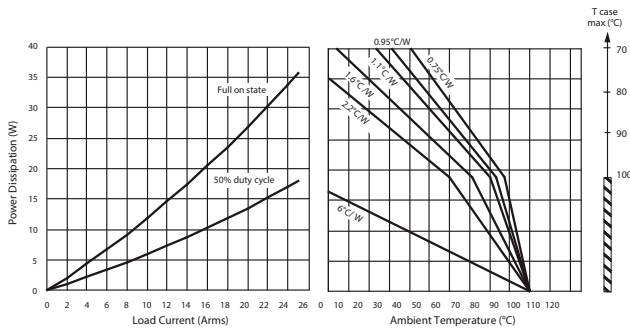

Figure 5b — 25A output current

- NOTES:
1. Electrical specifications measured at 25°C unless otherwise specified.
 2. For 800Hz applications, contact factory.
 3. For additional/custom options, contact factory.

OPTIONAL ADD-ONS

- Please order add-ons separately:
- -12 — Thermal pad installed.
 - -14 — Plastic touch-proof cover.

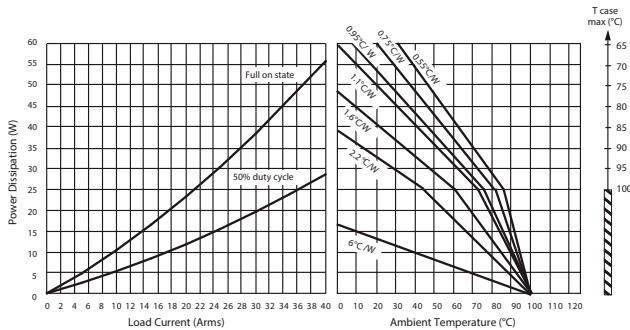

Figure 5c — 40A output current

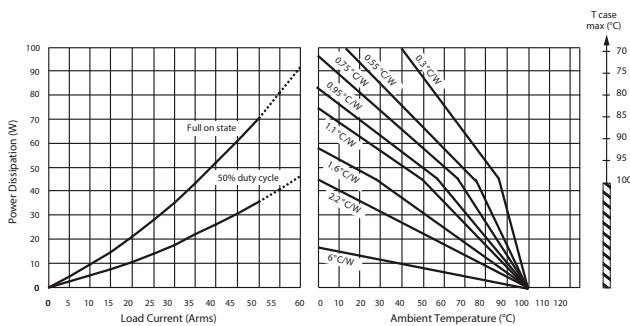

Figure 5d — 50A output current